

Desarrollo standard

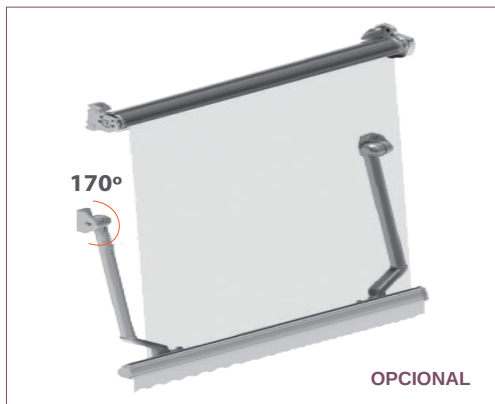

Desarrollo con doble caída



Brazos en aluminio con tensión

CARACTERÍSTICAS

MEDIDAS				
LINEA MÁXIMA	SALIDA MÁXIMA	90°	170°	LINEA MÍNIMA (con motor)
5000	600	✓	✓	840
5000	800	✓	✓	
5000	1000	✓	✓	
5000	1200	✓	✓	
5000	1400	✓	✓	

Clase III
Según norma EN13561



ABACO CLASIFICACION AL VIENTO						
3000	3500	4000	4500	5000	L	S
						600
						800
						1000
						1200
						1400

49 km/h Clase III 38 km/h Clase II 29 km/h Clase I

INSTALACIÓN

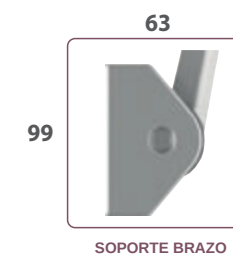
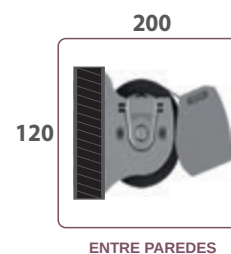
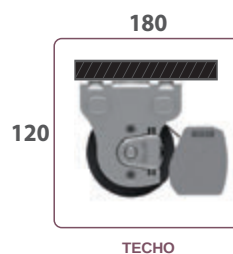
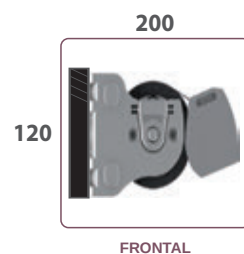

ACCIONAMIENTO



MANUAL

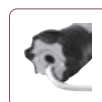

MOTOR (Standard iO) OPCIONAL

CERTIFICACIONES



MARCA CE



TORNILLERIA



LACADO

COLORES BASE



COLORES STANDARD



MÁS INFORMACIÓN APP

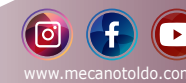

www.mecanotoldo.com