

Ce manuel a été écrit afin de fournir les informations nécessaires pour permettre l'installation du produit.

CONSIDÉRATIONS ET SÉCURITÉ

- Toute manipulation ou modification effectuée sans autorisation de MECANOTOLDO exonère cette dernière de toute responsabilité pour les dommages pouvant survenir.
- Le personnel chargé de ces opérations doit avoir connaissance techniciens de produits.
- Les opérations d'installation doivent être effectuées dans des endroits suffisamment éclairés, conformément à des réglementations spécifiques.
- Portez des vêtements et des vêtements de protection personnels prévus par les règles de sécurité applicables.

ENTRETIEN

- Arrêter le store dans des conditions météorologiques défavorables telles que:



- Pendant la manœuvre d'ouverture ou de fermeture, vérifiez qu'il n'y ai pas d'obstacles.
- Maintenir l'installation propre et en bon état.
- Une vérification annuelle de maintenance est recommandée par un installateur autorisé.

RAPPELÉZ-VOUS QUE LE STORE EST UN SYSTÈME DE PROTECTION SOLAIRE

LA VIE DE VOTRE STORE DEPENDE AUSSI DE VOUS



mecanotoldo

Crta. Girona C-250 Km5 17242 (QUART)
Telf: 0034 972 468 999 Fax: 0034 972 469 7177

GIRONA - ESPAÑA

www.mecanotoldo.com

france@mecanotoldo.com



5036

Vue Éclatée

- 1 - Barre d'enroulement
- 2 - Kit profiles coffre
- 3 - Tourillon
- 4 - Tourillon treuil
- 5 - Supports
- 6 - Bouchons latéraux alu
- 7 - Treuil
- 8 - Griffes
- 9 - Bouchons profil charge
- 10 - Bras Concept



Prise de Mesure

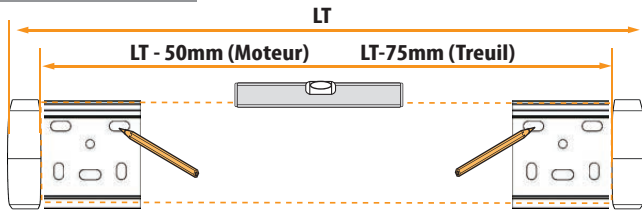

Percer et Cheviller

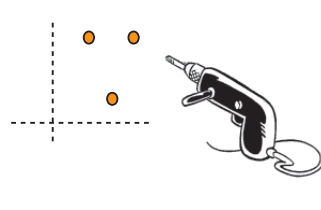

Fixation des supports

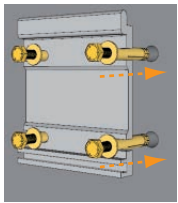

Face

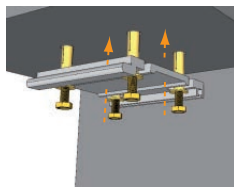

Plafond

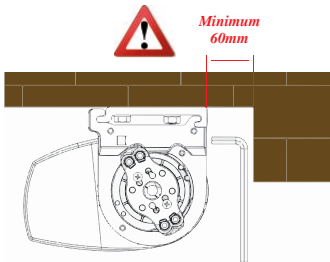

Minimum 60mm

Montage du coffre



Insérer

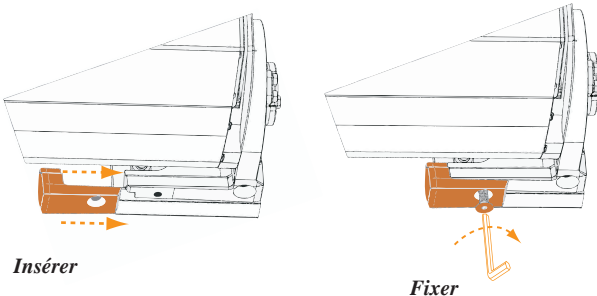

Fixer

Réglage de l'inclinaison

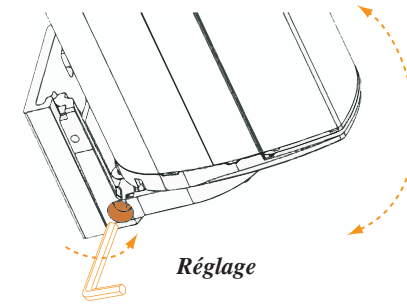

Réglage

Colocación Tapas Laterales

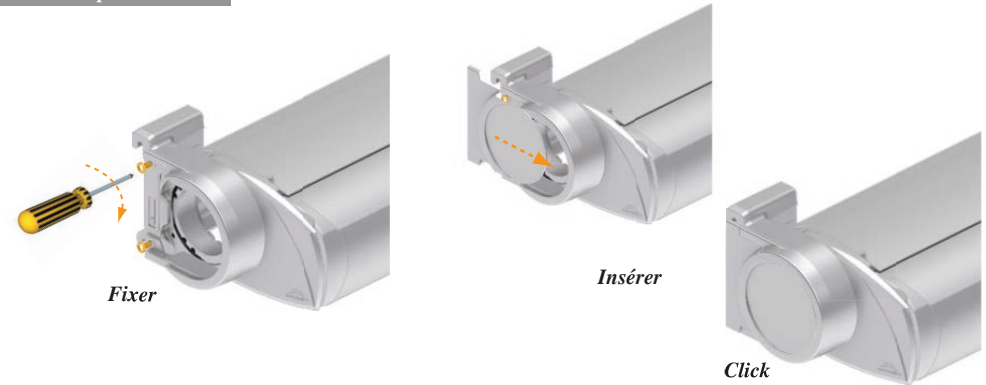

MOTORIZATION



CÂBLE DE RÉGLAGE MOTEURS WT (NECESSAIRE)

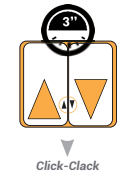

Click-Clack

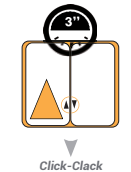

Click-Clack



Click-Clack

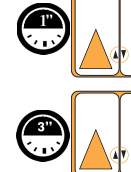

Click-Clack



Click-Clack

CONNECTEZ LE MOTEUR A L'INTERRUPTEUR

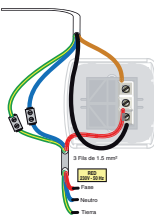

Appuyer simultanément montée et descente



Click-Clack

Vérification du sens de rotation

Montée

Descente



Click-Clack

Changer le sens de rotation

Appuyer "my"



Click-Clack

Réglage des fins de courses

Descente



Click-Clack

Mémoriser

Appuyer "my"



Click-Clack

Programmer

Appuyer le bouton arrière



Click-Clack



Appuyer simultanément montée et descente



Click-Clack

Montée

Descente



Click-Clack

Appuyer "my"



Click-Clack

Descente



Click-Clack

Appuyer simultanément "my" et montée



Click-Clack

Appuyer "my"



Click-Clack

Appuyer le bouton arrière



Click-Clack